

# WCU-4

## Wireless Compact Unit

USER MANUAL

12th December 2018



## Imprint

Copyright © 2018 Arnold & Richter Cine Technik GmbH & Co. Betriebs KG. All rights reserved. No parts of this document may be reproduced without prior written consent of Arnold & Richter Cine Technik GmbH & Co. Betriebs KG. Specifications are subject to change without notice. Errors, omissions, and modifications excepted.

ARRI, ALEXA, AMIRA, Master Grip, LDS and LENS DATA SYSTEM are trademarks or registered trademarks of Arnold & Richter Cine Technik GmbH & Co. Betriebs KG. All other brands or products are trademarks or registered trademarks of their respective holders and should be treated as such. Original version.

## For Further Assistance

ARRI Cine + Video Geräte Gesellschaft m.b.H.

Pottendorferstraße 23-25/3/1

A-1120 Vienna Austria

E-mail: [service@arri.com](mailto:service@arri.com)

Website: [www.arri.com](http://www.arri.com)

## Scope

This User Manual applies to the following product:

K2.72103.0 WCU-4 with Software Update Packet SUP 3.2

## Revision history

Version	ID	Order #	Release	Date
01	10000445	K5.74422.0	FG1156	17.06.2013
02	10000445	K5.74422.0	W01003	27.11.2013
03	10000445	K5.74422.0	W01004	15.01.2014
04	10001397	K5.74422.0	W01071	09.02.2015

05	10001397	K5.74422.0	W01077	28.09.2015
06	10001397	K5.74422.0	W01107	02.05.2016
07	10001397	K5.74422.0	W01136	20.07.2017
08	10001397	K5.74422.0	W01453	12.12.2018

## Disclaimer

Before using the products described in this manual, be sure to read and understand all the respective instructions.

The ARRI Wireless Compact Unit WCU-4 is/are only available to commercial customers. By utilization, the customer agrees that the WCU-4 or other components of the system are deployed for commercial use only. Otherwise the customer must contact ARRI before utilization.

While ARRI endeavors to enhance the quality, reliability and safety of their products, customers agree and acknowledge that the possibility of defects thereof cannot be eliminated entirely. To minimize the risk of damage to property or injury (including death) to persons arising from defects in the products, customers must incorporate sufficient safety measures in their work with the system and heed the stated canonic use.

ARRI or its subsidiaries do not assume any responsibility for losses incurred due to improper handling or configuration of the WCU-4 or other system components.

ARRI assumes no responsibility for any errors that may appear in this document. The information is subject to change without notice.

For product specification changes after this manual was published, refer to the latest published ARRI data sheets or release notes, etc., for the most up-to-date specifications. Not all products and/or types are available in every country. Please check with an ARRI sales representative for availability and additional information.

Neither ARRI nor its subsidiaries assume any liability for infringement of patents, copyrights or other intellectual property rights of third parties by or arising from the use of ARRI products or any other liability arising from the use of such products. No license, express, implied or otherwise, is granted under any patents, copyrights or other intellectual property right of ARRI or others.

ARRI or its subsidiaries expressly exclude any liability, warranty, demand or other obligation for any claim, representation, cause, action, or whatsoever, express or implied, whether in contract or not, including negligence, or incorporated in terms and conditions, whether by statute, law or otherwise. In no event shall ARRI



or its subsidiaries be liable for or have a remedy for recovery of any special, direct, indirect, incidental, or consequential damages, including, but not limited to lost profits, lost savings, lost revenues or economic loss of any kind or for any claim by a third party, downtime, good-will, damage to or replacement of equipment or property, any cost or recovery of any material or goods associated with the assembly or use of our products, or any other damages or injury of the persons and so on or under any other legal theory.

In the event that one or all of the foregoing clauses are not allowed by applicable law, the fullest extent permissible clauses by applicable law are validated.

# Table of Contents

<b>1</b>	<b>For your safety</b> .....	<b>8</b>
<b>2</b>	<b>Audience and intended use</b> .....	<b>10</b>
<b>3</b>	<b>Scope of delivery and warranty</b> .....	<b>11</b>
<b>4</b>	<b>Introduction</b> .....	<b>12</b>
<b>5</b>	<b>Getting started</b> .....	<b>15</b>
<b>6</b>	<b>Overview</b> .....	<b>17</b>
	6.1 Wireless and wired operation.....	17
	6.2 Control functionalities.....	17
	6.3 LDS - Lens Data System.....	17
	6.4 Hardware combinations.....	19
<b>7</b>	<b>Layout</b> .....	<b>20</b>
<b>8</b>	<b>Control panel</b> .....	<b>23</b>
<b>9</b>	<b>Home screen</b> .....	<b>25</b>
	9.1 Motor calibration.....	27
	9.2 Camera remote.....	28
	9.2.1 <i>Playback control</i> .....	28
	9.2.2 <i>Setup</i> .....	29
	9.2.3 <i>Monitor out</i> .....	31
	9.2.4 <i>User</i> .....	32
	9.3 Focus setup.....	33
	9.4 Iris setup.....	35
	9.5 Zoom setup.....	36
	9.6 Override Mode.....	38
<b>10</b>	<b>Menu</b> .....	<b>41</b>
	10.1 Radio channel.....	42
	10.2 Control setup.....	43
	10.3 Motor setup.....	46
	10.4 Premarked focus ring.....	49
	10.5 Lens data.....	50
	10.5.1 <i>Lens programming</i> .....	51
	10.5.2 <i>Lens file transfer</i> .....	62

---

	10.5.3	<i>Circle of confusion</i> .....	64
	10.5.4	<i>Global Unit</i> .....	64
	10.5.5	<i>Data Source</i> .....	65
	10.5.6	<i>Clear LDA</i> .....	66
	10.6	User buttons.....	67
	10.7	Backlight.....	69
	10.8	User settings.....	70
	10.9	Firmware.....	71
	10.9.1	<i>LBUS update</i> .....	74
	10.10	System info.....	76
	10.10.1	<i>Region settings</i> .....	77
<b>11</b>		<b>Appendix</b> .....	<b>78</b>
	11.1	Screen icons.....	78
	11.2	SD card.....	80
	11.3	Screen messages.....	80
	11.4	Part numbers.....	82
	11.5	Compatibility.....	84
	11.6	Pinouts.....	89
	11.7	Dimensions and weight.....	90
	11.8	Radio system.....	91
	11.9	Service mode.....	92
	11.10	Service Contacts.....	96
	11.11	International declarations.....	97

# 1 For your safety

Before use, please ensure that all users read, understand, and follow the instructions comprehensively in this document.

## Risk levels and alert symbols

Safety warnings, safety alert symbols, and signal words in these instructions indicate different risk levels:

### **DANGER!**

*DANGER* indicates an imminent hazardous situation, which, if not avoided, **will result in** death or serious injury.

### **WARNING!**

*WARNING* indicates a potentially hazardous situation, which, if not avoided, **may result in** death or serious injury.

### **CAUTION!**

*CAUTION* indicates a potentially hazardous situation, which, if not avoided, **may result in** minor or moderate injury.

### **NOTICE**

*NOTICE* explains practices not related to physical injury. No safety alert symbol appears with this signal word.

**Note:** Provides additional information to clarify or simplify a procedure.

## Vital precautions

### DANGER!

#### **Risk of electric shock and fire!**

Short-circuits may entail lethal damage!

Before use, read and follow all valid instructions.

Use solely and exclusively as described in the instructions.

Never open. Never insert objects.

For operation, always use a power source as indicated in the instructions.

Always unplug the cable by gripping the plug, not the cable.

Never try to repair. All repair work should be done by a qualified ARRI Service Center.

Never remove or deactivate any safety equipment (incl. warning stickers or paint marked screws).

Always protect from moisture, cold, heat, dirt, vibration, shock, or aggressive substances.

## General precautions

Use only the tools, materials and procedures recommended in this document. Unplug all cables during transport.

Do not store the WCU-4 in places where it/they may be subject to temperature extremes, direct sunlight, high humidity, severe vibration, or strong magnetic fields.

## 2 Audience and intended use

### ***NOTICE***

The product is solely and exclusively available for commercial costumers and shall be used by skilled personnel only. Every user should be trained according to ARRI guidelines. Use the product only for the purpose described in this document. Always follow the valid instructions and system requirements for all equipment involved.

The WCU-4 is solely and exclusively for use on professional camera setups.

### 3 Scope of delivery and warranty

#### **NOTICE**

Product and packaging contain recyclable materials. Always store, ship, and dispose of according to local regulations. ARRI is not liable for consequences from inadequate storage, shipment or disposal.

#### **Delivery**

On delivery, please check that the package and content are intact. Never accept a damaged or incomplete delivery. A complete delivery includes:

- Wireless Compact Unit WCU-4
- Hand strap
- Lanyard
- Plain white marking ring
- SD-Card
- User manual
- Original packaging

#### **Warranty**

For scope of warranty, please ask your local ARRI Service Partner. ARRI is not liable for consequences from inadequate shipment, improper use, or third-party products.

## 4 Introduction

The Wireless Compact Unit WCU-4 is a lightweight, ergonomic hand unit offering up to 3-axis lens control. Rugged and splash proof, it features an easy-to-read lens data display, vibrating alerts that allow focus pullers to keep their eyes on the action and camera remote control functionality. The large lens data display reflects ambient light and remains clearly visible even in direct sunlight, while the backlit focus knob and control buttons allow the WCU-4 to also be used in darkness.

### **WCU-4 Main Features:**

- Ergonomic 3-axis lens control
- Vibrating markers
- Easy-to-read lens data display
- Distance readout
- Backlit focus knob with adjustable friction
- Premarked focus rings
- Focus tracking function
- Lens programming interface
- Lens file management on SD card
- Wireless lens file transfer
- Remote REC and tally
- Advanced camera remote control
- Full playback control
- Support of override function

### ***NOTICE***

To tap the full potential of the device, have all connected units updated to the latest available firmware.



**NOTICE**

Some functions may only be available with the ALEXA Remote License, available from the ARRI license shop:



<http://alshop.arri.de>



Visit [www.arri.com](http://www.arri.com) for up-to-date product information and software updates.

## How to use this manual

Connectors are all written in capital letters, for example, **LCS**.

Buttons are all written in capital letters, for example, **MENU** soft button.

Menus and screens are written in italic letters, for example *Home* screen.

The appendix at the back of the manual contains useful reference material including radio frequencies, spare parts and additional accessories, connector pin-out diagrams and dimensional drawings.

## 5 Getting started

This quick start guide takes you through setting up the WCU-4 with a motor controller and up to three motors for wireless lens control.

### Setting up motor controller

First, set up the motor controller on the camera. For details, please consult the motor controller manual. Make sure to set the correct motor side/direction and torque.

### Powering up hand unit

Insert a Sony NP-FM 500H Li-Ion battery (ARRI order no. K2.47851.0), or connect the hand unit via cable.

Press the **POWER** button momentarily. The WCU-4 screen will light up.

### Connecting to motor controller

Press the **MENU** button. Enter the Radio Channel menu. Select the same radio channel as set on the corresponding ARRI motor controller with white-coded radio modem. Check for proper region settings (See "Region settings", page 77)

Make sure that the radio transmission is switched on (upper center soft button). Return to Home screen by pressing the **BACK** or **HOME** button. The selected radio channel will be indicated in the top center area of the *HOME* screen. A signal strength indicator will be displayed as soon as a connection between WCU-4 and motor controller is established.

#### **NOTICE**

It may not be legal to operate the Wireless Control Unit WCU-4 in a country/region other than the country/region selected in the WCU-4 region menu. Switch radio off and use the device in hardwired mode if you are unsure of the correct region setting.

## Calibrating motors

Calibrate the motor(s) by pressing the **CAL** soft button on the WCU-4 *Home* screen or on the motor controller.

### NOTICE

Note: Motors must be recalibrated under the following conditions:

- When a motor is detached from the lens
- After changing motors
- After changing lenses
- After a change in a motor position while powered down

### NOTICE

Omitting motor calibration might lead to damage of the lens due to the high level of motor torque!

## Using a premarked focus ring

The use of premarked focus rings on the WCU-4 hand unit requires lens data from the motor controller or camera.

Press the WCU-4 **MENU** button. Enter the *Premarked Focus Ring* menu and select a focus ring. Return to *Home* screen by pressing the **BACK** or **HOME** button. The selected focus ring will be indicated next to the numerical focus value in the center of the screen. The digital focus scale on the display will now align with the premarked focus ring.

You are now ready to shoot.

## 6 Overview

### 6.1 Wireless and wired operation

The WCU-4 can be connected wirelessly or hardwired to camera or motor controller. Three hand units are operable wirelessly in parallel. In both modes, wired or wireless, all remote control functions are given.

In hardwired operation, the WCU-4 is powered via cable (See "Electrical data", page 91 for information about the power supply). Unplugging the cable forces the WCU-4 to shutdown. The connection mode is displayed in *Home* screen (See "Screen icons", page 78).

### 6.2 Control functionalities

The WCU-4 is capable to control up to three axis (focus/iris/zoom), start/stop the recording, and control other camera parameters (See "Camera remote", page 28).

### 6.3 LDS - Lens Data System

#### Lens data

Lens data is a continuous stream of information about the focus, iris and zoom settings of a lens. The data is sent by either camera or motor controller.

Lens data is displayed on the WCU-4 *Home* screen.

#### Lens mapping

Lens mapping is the mapping of a lens focus scale to a predefined, premarked focus ring on the WCU-4. See "Premarked focus ring", page 49 for further information.

## **Focus tracking**

Focus tracking is a continuous, automatic focus adjustment based on the distance measured by an ultrasonic measuring device such as the UDM-1. The distance information will be forwarded from the camera or the motor controller to the WCU-4.

## 6.4 Hardware combinations

The WCU-4 can be combined with hardware shown below.

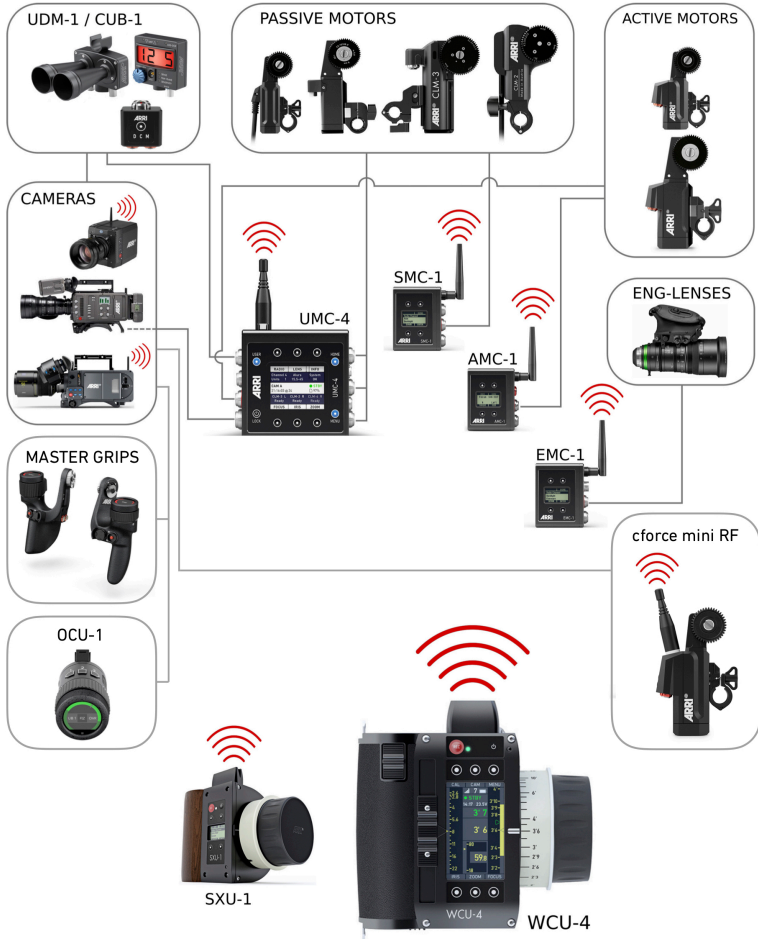

### NOTICE

See "Compatibility", page 84 for detailed information about hardware compatibility.

# 7 Layout

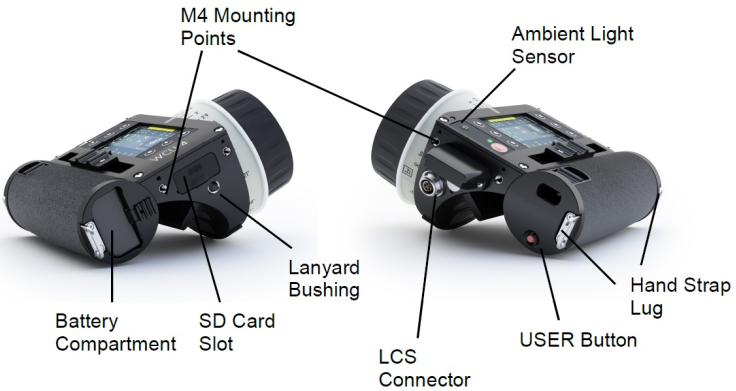
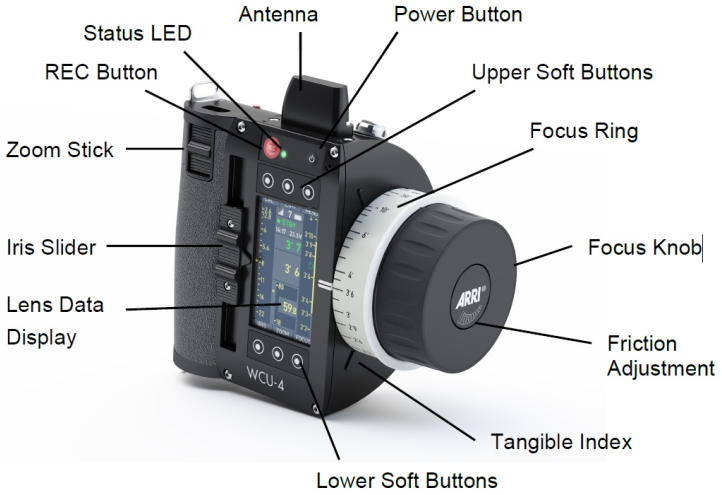



<b>Interface</b>	<b>Description</b>
Antenna	Integrated antenna.
Power Button	Switches the unit on/off. Press button briefly to power-on the unit. Press and hold for approx. 3 seconds to turn off the unit.
REC Button	Press button briefly to start/stop recording.
Status LED	Displays the same status as currently shown on the camera.
Ambient Light Sensor	Controls display luminance as well as scale ring and button illumination in automatic mode.
Upper Soft Buttons	Press button briefly to select the menu item shown below.
Lower Soft Buttons	Press button briefly to select the menu item shown above.
USER Button	User configurable push button.
Screen	3" transfective TFT color panel. Displays camera and lens status and control information.
Focus Knob	Controls focus lens motor. Re-configurable to iris lens motor control.
Friction Adjustment	Adjusts the friction for the focus knob. Press and hold the center button. Turn the focus knob clockwise to increase the friction. Turn the focus knob counterclockwise to decrease the friction.
Iris Slider	Controls iris lens motor. Re-configurable to focus lens motor control.

Zoom Stick	Pressure-sensitive switch that controls zoom lens motor and can be used to scroll through the menu.
Tangible Index	Tangible reference point near the focus knob.
Battery Compartment	Push in the battery completely when loading. Shift the release slider to release the battery.
SD Card Slot	Protected by rubber cap. Insert SD card 'face up'.
Lanyard Bushing	Attach the lanyard here.
Hand Strap Lug	Attach the hand strap here.
M4 Mounting Points	M4 mounting points for optional accessories.



*WCU-4 with mounting plate  
(K2.0006501)*

## 8 Control panel

The WCU-4 features a comfortable and comprehensive user interface with backlit buttons, enabling the user to quickly configure the system. The 3" transfective LCD display shows vital lens and camera information, and is easily readable in any ambient light conditions.



### Power button

Press the power button momentarily to switch the WCU-4 on. To switch the WCU-4 off, press the button for three seconds and a countdown is displayed. If the button is released before the countdown has elapsed, the WCU-4 does not shut down.

## Soft button

Six soft buttons are located above and below the display. They change their behavior depending on the screen content, indicating the function related to each button. Buttons without a label have no function in that screen.

## Menu navigation

To access a new menu level, press the **SELECT** soft button or press the **USER** button.

To go one level back up, press the **BACK** soft button.

Press the **HOME** soft button to return to the *Home* screen.

Use the **UP/DOWN** soft buttons or use the zoom stick to navigate through the menu. Keep the soft button pressed to scroll through the list.

A parameter displayed on the right-hand of the screen can be edited with the **CHANGE** soft button.

Press the **SET** soft button to activate a parameter list item.

## 9 Home screen

The *Home* screen is the default screen. It provides access to the main menu, the focus, iris and zoom menus, and the camera menu; it also activates motor calibration through its soft buttons.

In addition the *Home* screen displays the most important parameters of the hand unit, motor controller and camera (if available), and shows the current position of the motors attached to the focus, iris and zoom lens rings.

The distance readout of compatible measuring devices such as the Ultrasonic Distance Measure UDM-1, cfinder III or the Cine Tape Measure will automatically appear on the WCU-4 Home screen if connected to the respective motor controller or camera. The distance readout is displayed as green numbers in the center of the WCU-4 screen.

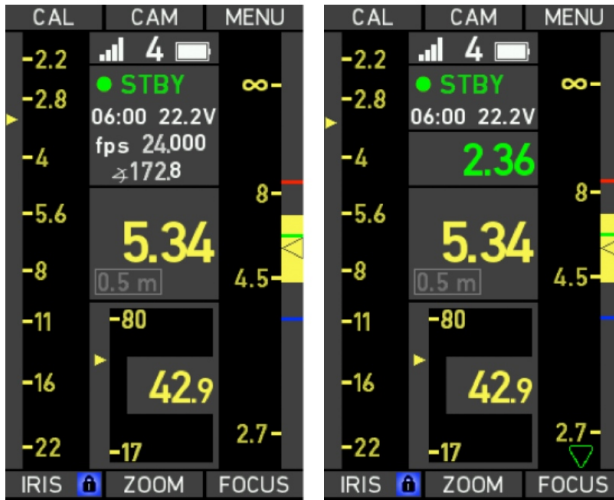

Note: Fast focus racks can result in an offset between the graphical focus scale on the lens data display and the actual position of the focus knob, as the lens motor can take more time to travel to the desired position than the focus knob does.

### Camera status

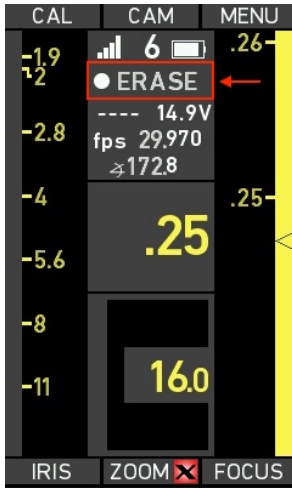

<b>Camera screen</b>	<b>WCU-4 Home screen</b>
REC	REC
PREREC	PRE
STBY	STBY
PLAY	PLAY
Erasing Card	ERASE
ERROR	ERROR
FULL	---

## 9.1 Motor calibration

Press the **CAL** soft button for three seconds to calibrate all motors attached to the motor controller.

### ***NOTICE***

Note: A lens motor must be recalibrated under the following conditions:

- When a lens motor is detached from the lens
- After changing lenses
- After a change in motor position while powered down

### ***NOTICE***

Omitting motor calibration might lead to damage of the lens due to the high level of motor torque!

## 9.2 Camera remote

The *CAM* screen displays detailed camera information, if available from the connected camera.

The optional ALEXA Remote License (See "Firmware", page 71) offers extended camera setup functionality, including:

- Frame Rate
- Shutter Angle
- Exposure Index
- White Balance (include custom values)
- ND Filter \*
- Monitor Output (SDI) Configuration
- User Button Access \*
- Playback Control

\* See "Cameras", page 84 for detailed compatibility information.

HOME	SETUP
<b>CAMERA INFO</b>	
CAMERA STATE: STBY	
FRAME RATE:	24.000
SHUTTER ANGLE:	172.8
EXPOSURE INDEX:	800
ND FILTER:	N/A
WHITE BALANCE:	5600 0.0CC
BATTERY:	
REC TIME:	50:41
CODEC:	
	ProRes 4444
CAMERA INDEX:	A
LENS MODEL:	
	Fujinon Alura AZ15.5-45 T...
USER	PLAY SDI

### 9.2.1 Playback control

Full remote playback control allows users to wirelessly select, play back and shuttle through any clip without needing direct access to the camera.

Press the **PLAY** soft button on the *CAM* screen to enter the *Playback* screen. The *Playback* screen shows the last recorded clip by the camera and detailed information like *Medium, Start TC, Duration, Frame Rate and Codec* .





#### PLAYBACK:

Use the softbuttons << / >> or the zoom control stick for controlling playback speed (max 64x).

#### PAUSED:

Use the softbuttons << / >> or the zoom control stick to shuttle through clip frame-wise.

#### CLIPLIST:

Press the **CLIPS** soft button on the *Playback* screen to open the *Cliplist* screen to access all the clips recorded on the card.

To select a clip from the cliplist press the soft button **SELECT** .

To shuttle through the cliplist press the soft buttons **DOWN** or **UP** .

To select a card press the soft button **CARD** .

### 9.2.2 Setup

Press the **SETUP** soft button on the *CAM* screen to enter the *Camera setup* menu.

Use the **UP** and **DOWN** soft buttons or the zoom stick to select an option from the list. Press the **SELECT** soft button or the **USER** button to enter the corresponding sub-menu.

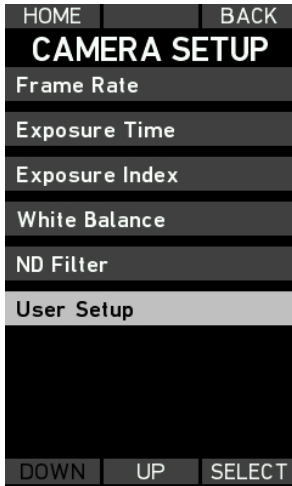

*Camera setup screen*

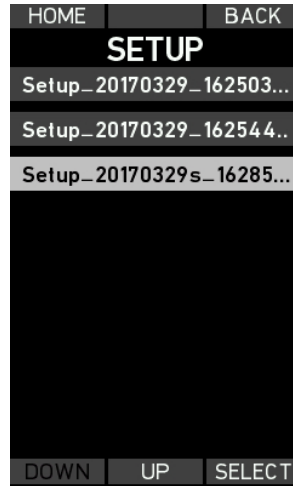

*User setup*

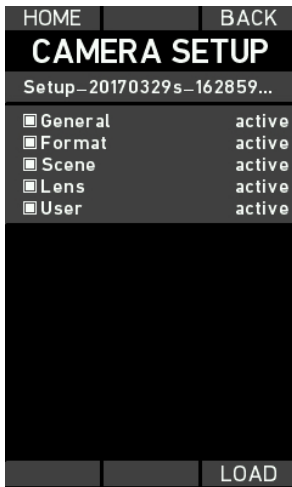

*Camera setup*

The *Frame Rate*, *Shutter Angle*, *Exposure Index* and *White Balance*, *ND Filter* and *User Setup* menu items contain a list of pre-set parameters from the camera.

Use the **UP** and **DOWN** soft buttons or the zoom stick to select a parameter from the list. Press the **SET** soft button or the **USER** button to activate the corresponding parameter on the camera.

### 9.2.3 Monitor out

Press the **SDI / MON** soft button on the *CAM* screen to enter the *Monitor out* screen. The *Monitor out* screen allows changing monitor output settings. Use the **UP** and **DOWN** soft buttons or the zoom stick to select a SDI monitor output option from the list. Press the **CHANGE** soft button or the **USER** button to activate or deactivate the corresponding output setting on the camera.

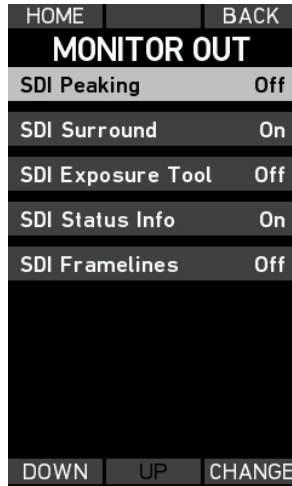
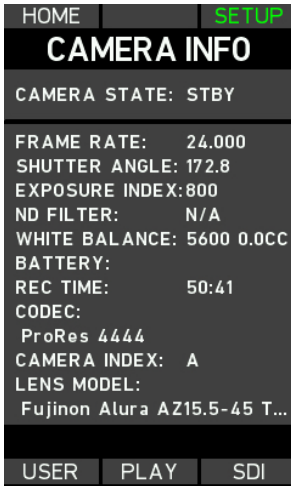

### 9.2.4 User

Press the respective **USER** soft button to activate or deactivate the corresponding function on the camera. The **USER** button function must be assigned at the camera.

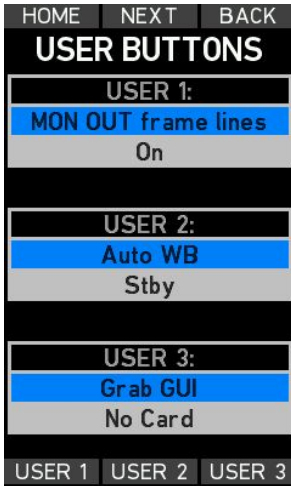

*User buttons 1-3*

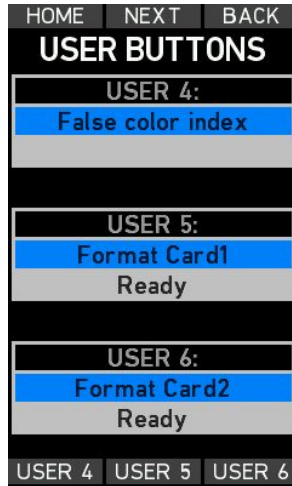

*User button 4-6*

## 9.3 Focus setup

Press the **FOCUS** soft button to enter the WCU-4 *Focus* screen. Pressing the **MARKER/MOTOR** soft button toggles the lower three soft buttons between *Motor* mode (**LIMIT**, **K-LIM**, **OFFSET**) and *Marker* mode (**MARK**, **RESET**, **REMOVE**).

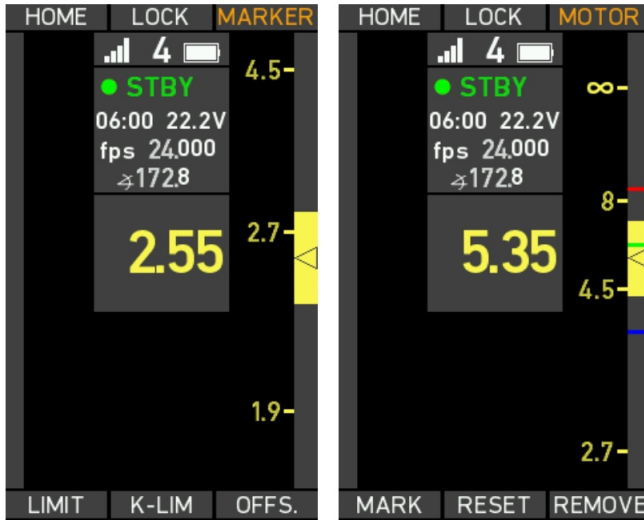

*Focus control screens with Motor mode (left) and Marker mode (right)*

### Limit

The **LIMIT** soft button lets you set a motor limit that limits the range of the motor on the lens (for example from 3' to 10'). To set a motor limit, proceed as follows:

- 1 Drive the motor to the first limit position.
- 2 Press and hold the **LIMIT** soft button.
- 3 Drive the motor to the second limit position.
- 4 Release the **LIMIT** soft button. A blue 'LIM' symbol will appear next to the **LIMIT** soft button, indicating that limits are set.

Press the **LIMIT** soft button again to deactivate the limits. The symbol will disappear.

### K-LIM

The **K-LIM** soft button lets you set focus knob limits. A knob limit limits the range of the focus knob. To set a knob limit, proceed as follows:

- 1 Set the focus knob to the first limit position.
- 2 Press and hold the **K-LIM** soft button.
- 3 Turn the knob to the second limit position.
- 4 Release the **K-LIM** soft button. A blue 'KNB' symbol will appear next to the **K-LIM** soft button, indicating that knob limits are set.

### Offset

The **OFFSET** function lets you correct an offset between the physical focus scale of a lens and the corresponding lens data values. To set an offset, proceed as follows:

- 1 Drive the lens ring to a witness mark, for example 3' 6".
- 2 Press and hold the **OFFSET** soft button.
- 3 Turn focus knob so the value in the WCU-4 display lines up the physical position on the lens ring.
- 4 Release the **OFFSET** soft button. An orange 'O' symbol will appear next to the **OFFSET** soft button, indicating that an offset is set.

Press **OFFSET** again to deactivate the offset. The symbol will disappear.

### Mark

Press the **MARK** soft button to set a digital focus mark at the current focus knob position. A colored line will appear on the lens data display focus scale. Up to eight color-coded focus marks can be set. The WCU-4 will vibrate when passing a mark with the focus knob, if vibration is activated.

### Reset

Press the **RESET** soft button to remove all focus marks.

### Remove

To remove a single focus mark, align the focus mark with the focus index and press the **REMOVE** soft button.

### Lock

Press the **LOCK** soft button to lock the focus knob. A blue padlock symbol will appear next to the **LOCK** soft button and next to the **FOCUS** soft button on the *Home* screen. Press the **LOCK** soft button again to unlock the focus knob. The blue padlock symbol will disappear.

## 9.4 Iris setup

Press the **IRIS** soft button to enter the WCU-4 *Iris* menu. It allows the setting of iris motor limits as well as locking of the iris slider.

### Limit

The **LIMIT** soft button lets you set motor limits. To set a motor limit, proceed as follows:

- 1 Drive the motor to the first limit position.
- 2 Press and hold the **LIMIT** soft button.
- 3 Drive the motor to the second limit position.
- 4 Release the **LIMIT** soft button. A blue 'LIM' symbol will appear next to the **LIMIT** soft button, indicating that limits are set.

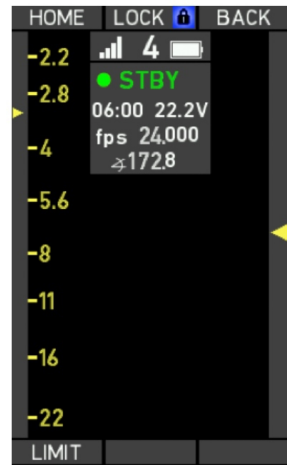

Press the **LIMIT** soft button again to deactivate the limits. The symbol will disappear.

### Lock

Press the **LOCK** soft button to lock the iris slider. A blue padlock symbol will appear next to the **LOCK** soft button and next to the IRIS soft button on the *Home* screen. Press the **LOCK** soft button again to unlock the iris slider. The blue padlock symbol will disappear.

## 9.5 Zoom setup

Press the **ZOOM** soft button to enter the *Zoom* menu. It allows the setting of zoom motor limits and zoom control speed, as well as locking of the zoom stick.

### Limit

The **LIMIT** soft button lets you set motor limits. To set a motor limit, proceed as follows:

- 1 Drive the motor to the first limit position.
- 2 Press and hold the **LIMIT** soft button.
- 3 Drive the motor to the second limit position.
- 4 Release the **LIMIT** soft button. A blue 'LIM' symbol will appear next to the **LIMIT** soft button, indicating that limits are set.



Press the **LIMIT** soft button again to deactivate the limits. The symbol will disappear.

### Zoom speed

Press the lower center soft button to set the zoom control speed. The currently selected speed is displayed on the soft button label.



Use the **UP** and **DOWN** soft buttons to change the zoom speed value (*0* is lowest, *100* is highest). Use the zoom stick to try the currently selected speed value. Use the **SET** soft button to confirm the current setting.

### Lock

Press the **LOCK** soft button to lock the zoom stick. A blue padlock symbol will appear next to the **LOCK** soft button and the **ZOOM** soft button on the *Home* screen. Press the **LOCK** soft button again to unlock the zoom stick. The blue padlock symbol will disappear.

## 9.6 Override Mode

The WCU-4 indicates the Override mode which is triggered by the Operator Control Unit OCU-1 or the Master Grips (SUP 2.0). The override function enables operators to override and return focus, iris or zoom at the touch of a button on the OCU-1/Master Grips.

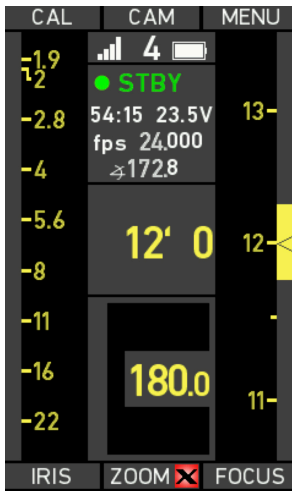

WCU-4 has control over all lens axis.

WCU-4 lens scales are black.

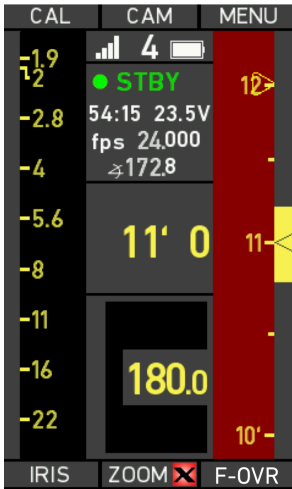

Operator Control Unit OCU-1 overtook focus control from WCU-4. WCU-4 focus scale turns red. WCU-4 has no control over focus axis.

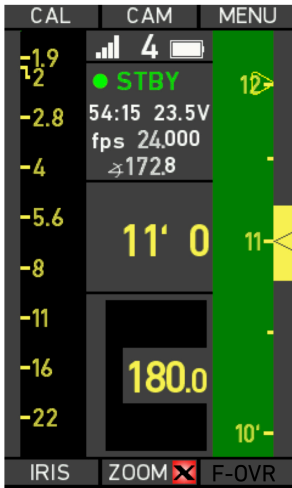

Operator Control Unit OCU-1 gives back focus control to WCU-4. WCU-4 focus scale turns green. Focus is still offset (set at the old focus position from WCU-4).



Move yellow triangle by turning the WCU-4 focus knob to the index mark. WCU-4 re-engages lens motor control without a jump.

To deactivate Override mode press the respective **F-OVR** soft button.

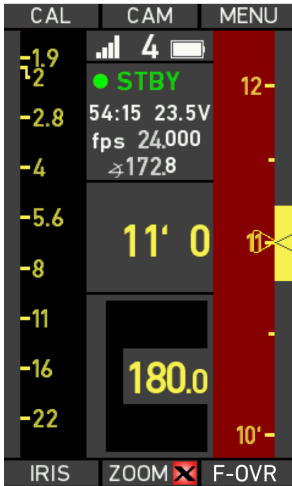

To prevent the motor from jumping, align the yellow triangle with the index mark before deactivating the Override mode.

## 10 Menu

Press the **MENU** soft button to enter the WCU-4 main menu. The main menu contains all parameters for the basic WCU-4 and motor setup.

HOME	BACK
<b>MENU</b>	
Premarked Focus Ring	
Radio Channel	3
Control Setup	
Motor Setup	
Lens Data	
User Button	
Backlight	9 AUTO
User Settings	
DOWN	UP SELECT

HOME	BACK
<b>MENU</b>	
Control Setup	
Motor Setup	
Lens Data	
User Button	
Backlight	9 AUTO
User Settings	
Update	
System Info	
DOWN	UP SELECT

## 10.1 Radio channel

The *Radio* menu lets you switch the radio on and off and select the radio channel. The currently selected radio channel is shown in the center of the screen.

Use the **UP** and **DOWN** soft buttons or the zoom stick to select the radio channel. Confirm the selection by pressing the **SET** soft button. Pressing the **SET** soft button will automatically return to the *Home* screen. Select the same channel on the WCU-4 and the corresponding motor controller.



See "Region settings", page 77 for further radio settings.

## 10.2 Control setup

The *Control setup* screen provides an overview of the current WCU-4 control configuration.

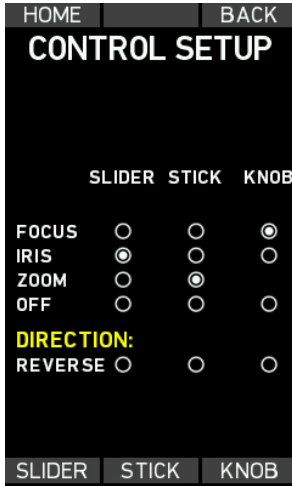

*Control setup screen*

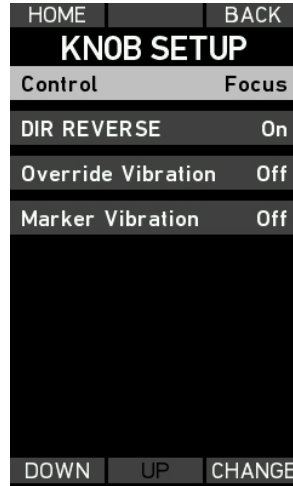

*Knob setup screen*

### Knob

Enter the *Knob setup* screen by pressing the **KNOB** soft button.

Use the **UP** and **DOWN** soft buttons or the zoom stick to select *Control* and press the **CHANGE** soft button to assign the knob control to the focus or iris motor or to switch the knob control off.

Use the **UP** and **DOWN** soft buttons or the zoom stick to select *DIR REVERSE* and press the **CHANGE** soft button to reverse the direction of the focus or iris scale.

Use the **UP** and **DOWN** soft buttons or the zoom stick to select *Override Vibration* and press the **CHANGE** soft button to switch vibrations on and off. In case that *Override Vibration* is turned on, the WCU-4 will vibrate when the OCU-1 overtakes or returns lens control of the WCU-4.

Use the **UP** and **DOWN** soft buttons or the zoom stick to select *Marker Vibration* and press the **CHANGE** soft button to switch vibrations on digital focus marks on and off.

## Slider

Enter the *Slider setup* screen by pressing the **SLIDER** soft button.

Use the **UP** and **DOWN** soft buttons or the zoom stick to select *Control* and press the **CHANGE** soft button to assign the slider control to the iris or focus motor or to switch the slider control off.

Use the **UP** and **DOWN** soft buttons or the zoom stick to select *DIR REVERSE* and press the **CHANGE** soft button to reverse the direction of the focus, iris or zoom scale.

Use the **UP** and **DOWN** soft buttons or the zoom stick to select *Blank Screen* and press the **CHANGE** soft button to activate the blank screen mode for the iris scale on the *Home* screen. Use a water-based felt marker for manual iris marks on the white area next to the iris slider on the *Home* screen.



*Slider setup screen*

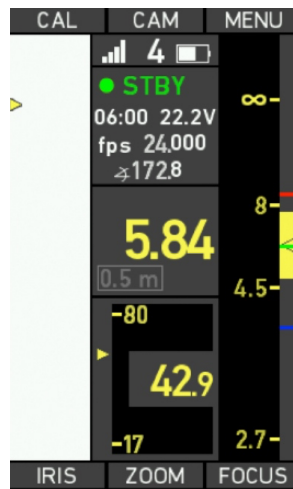

*Blank Screen mode*



## Stick

Enter the *Stick setup* screen by pressing the **STICK** soft button.

Use the **UP** and **DOWN** soft buttons or the zoom stick to select *Control* and press the **CHANGE** soft button to assign the stick control to the iris, focus motor, the zoom motor or to switch the stick control off.

Use the **UP** and **DOWN** soft buttons or the zoom stick to select *DIR REVERSE* and press the **CHANGE** soft button to reverse the direction of the focus, iris or zoom scale.



Note: A motor can only be assigned to one control interface at a time. Assigning the knob to the iris motor will automatically switch the slider to the focus motor and vice versa.

Assign the motor controls manually according to your preferences when using multiple hand units in network mode.

## 10.3 Motor setup

The *Motor setup* menu allows the torque and direction of the focus, iris and zoom motors to be set.



*Motor setup screen*

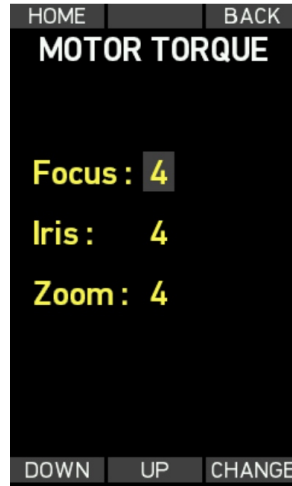

*Torque setup screen*

### Torque

The torque of all motors (except CLM-2) can be adapted to prevent sensitive lenses from mechanical overload. Torque setting is not available for the CLM-2 motor.

Select *Torque* to enter the *Motor torque* setup screen.

Use the **UP** and **DOWN** soft buttons or the zoom stick to select between focus, iris and zoom motors.

Use the **CHANGE** soft button to toggle through the torque values (1 is lowest, 4 is highest).

## NOTICE

Ensure that the motor torque level matches the lens to avoid lens damage. Stiff, hard-to-move lenses require a higher torque level. For highspeed applications and large lenses, the torque may be set to higher values. For small, less ruggedly designed lenses, the torque should be set to lower values.

Some lens motors provide very high torque for high-speed lens drive. Be sure that lens, lens motors and rods are correctly adjusted and fastened. Re-calibrate motors after re-attachment of the motor and after each lens change! Ignoring this procedure can lead to severe lens damage.

### Side

Select *Side* to enter the *Motor direction* setup screen.

The direction setting determines the motor drive direction, affecting the response to the hand control. The direction setting for lens motors refers to mounting on standard support rods on the bottom of the camera.

Use the **UP** and **DOWN** soft buttons or the zoom stick to select between focus, iris and zoom motors. Use the **CHANGE** soft button to toggle through the direction options (*Left*, *Right*).



Note: The correct direction setting is crucial for correct lens metadata generation.

## Teeth

ARRI offers module 0.8 motor gears with teeth counts of 40, 50 and 60 teeth.

The *Motor teeth* setting allows you to have the motor controller automatically detect the amount of teeth on the motor gear being used, or to select it manually.

Use the **UP** and **DOWN** soft buttons or the zoom stick to select between focus, iris and zoom motors.

Use the **CHANGE** soft button to select between automatic gear detection or manual gear selection (40, 50 or 60 teeth).

Note: The correct teeth count setting is crucial for correct lens metadata generation. Currently, only ARRI gears with 40, 50 or 60 teeth are supported.

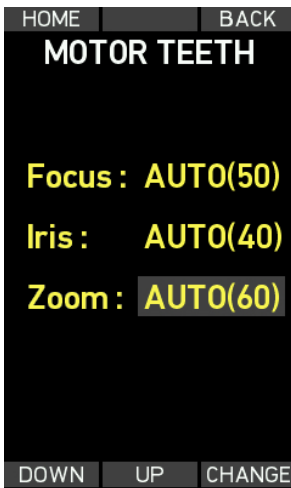

*Motor teeth setup screen (automatically)*

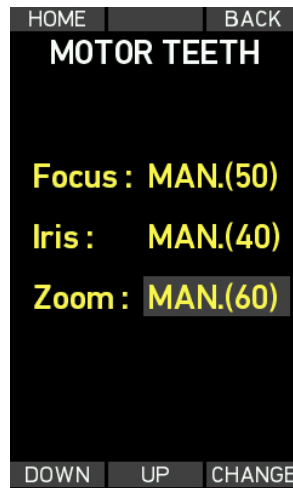

*Motor teeth setup screen (manually)*

## 10.4 Premarked focus ring

The WCU-4 offers lens mapping to premarked focus rings (See "Part numbers", page 82 for available premarked focus rings).

Enter the *Premarked focus ring* menu to select one of five different premarked focus rings, corresponding to the physical ring you are using on the WCU-4.

The displayed focus distance unit (metric/imperial) depends on the lens data setting of the motor controller. Change the distance unit on the motor controller if necessary.

Use the **UP** and **DOWN** soft buttons or the zoom stick to select your premarked focus ring. Press the **SET** soft button or the User button to activate lens mapping to that specific ring.

Note: Lens mapping to premarked focus rings requires lens data from the motor controller or camera. See "Compatibility", page 84 for supported hardware.

HOME		BACK	HOME		BACK
<b>FOCUS RING</b>			<b>FOCUS RING</b>		
Blank			Blank		
8"			0.2 m		
12"			0.25 m		
14"			0.35 m		
20"			0.5 m		
3'6"			1 m		
DOWN	UP	SET	DOWN	UP	SET

## 10.5 Lens data

The ARRI Lens Data System (LDS) allows display and capture of lens data information provided by cameras or motor controllers. The WCU-4 displays the same lens data on its integrated lens data display.

See "Compatibility", page 84 for devices which support LDS.

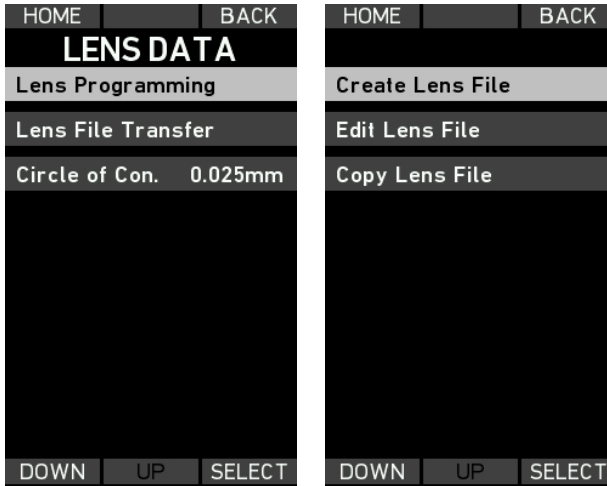

*Lens Data Menu  
screen*

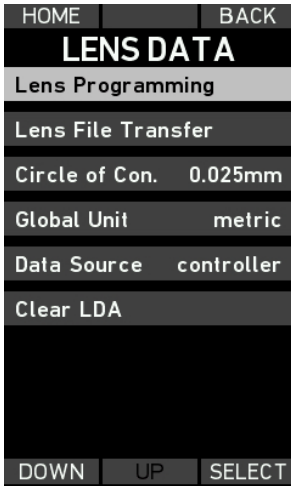

*Lens Data Menu screen (extended)*

In case a cforce mini RF lens motor or motor controller is connected to the camera the Lens Data Menu screen shows extended menu settings.

### 10.5.1 Lens programming

An important prerequisite for lens data generation is a lens table that converts the lens motor encoder values into something a human can use, like T-stops and focus ring values. Through lens programming, lens tables – and eventually lens data – can be generated for any lens.

The WCU-4 hand unit offers a lens-programming interface, so a lens can be quickly programmed, with no additional equipment besides a motor controller or camera with lens motors. The resulting lens table file is stored on an SD card, which can be taken out and reused elsewhere.

See "Compatibility", page 84 for lens programming abilities of your hardware.

### Required equipment

- Wireless Compact Unit WCU-4.
- Motor controller or camera, which supports LDS.
- At least one lens motor. We recommend using one motor per lens scale. If you have only one motor available but need to add more than one lens axis, you can create the lens scales sequentially, connecting the motor to the respective controller connector.
- SD card.

### ***Creating a lens file***

First, set up the motors on the lens and connect them to the camera or motor controller.

Establish a wireless or wired connection between WCU-4 and the motor controller.

Set the correct motor direction and torque.

Insert the SD card into the SD card slot of the WCU-4.

Go to *MENU > LENS DATA > LENS PROGRAMMING > CREATE LENS FILE.*

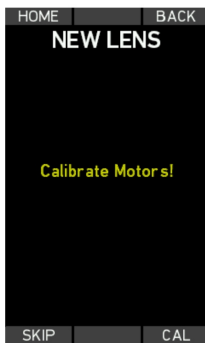

Press the **CAL** soft button to calibrate the lens motors.

Press the **SKIP** soft button if motors are already calibrated.





Select the lens brand.

Use the **UP** and **DOWN** soft buttons or the zoom stick to select the lens brand from the list.

Select *Custom* to enter a custom lens brand (see the following paragraph about how to enter custom names).

Press the **OK** soft button or the **USER** button to confirm the selection.

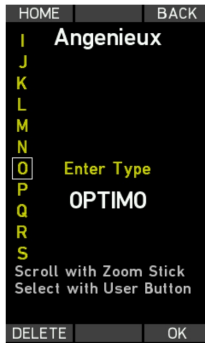

Enter the lens type.

Use the zoom stick to scroll through the characters on the left side of the screen. Press the **USER** button to select a character.

Press the **DELETE** soft button to delete a character.

Press the **OK** soft button to set the lens type.

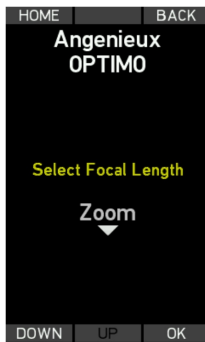

Select the focal length.

Use the **UP** and **DOWN** soft buttons or the zoom stick to select a focal length from the list.

Select *Custom* to enter a custom focal length.

Select *Zoom* for a zoom lens.

Press the **OK** soft button or the **USER** button to confirm the selection.

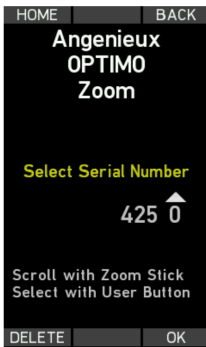

Enter the lens serial number.

Use the zoom stick to scroll through the numbers.

Press the **USER** button to select a number.

Press the **DELETE** soft button to delete the last number.

Press the **OK** soft button to set the serial number.

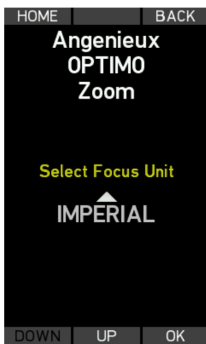

Select the focus unit (metric or imperial).

Use the **UP** and **DOWN** soft buttons or the zoom stick to select the focus unit.

Press the **OK** soft button or the **USER** button to confirm the selection.

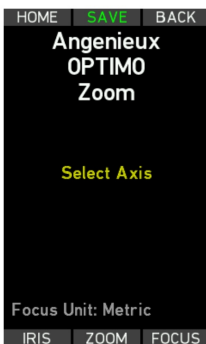

Select the lens axis to be programmed next.

Press the **FOCUS** soft button to program the focus scale.

Skip this step if you do not want to program the focus scale.

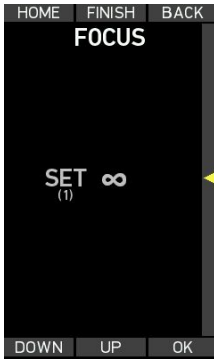

Use the focus knob to drive the lens focus scale to its infinity mark. Press the **OK** soft button or the **USER** button to set the infinity data point.



Use the focus knob to drive the lens focus scale to the close focus mark. Use the **UP** and **DOWN** soft buttons or the zoom stick to set the close focus value on the display. Press the **OK** soft button or the **USER** button to set the close focus data point. Repeat this procedure for the other data points. Make sure to distribute the data points as evenly as possible over the lens scale. Use **DOWN** to go back to a previous set data point for resetting. It is recommended to set at least 12-14 data points.



After setting the last focus point, press **FINISH** to finalize the focus programming procedure. Press the **OK** soft button to return to the *Select axis* screen.

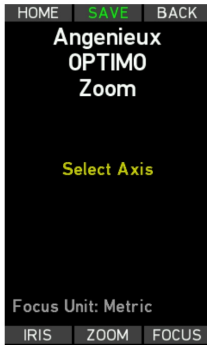

Select the lens axis to be programmed next.  
 Press the **IRIS** soft button to program the iris scale.  
 Skip this step if you do not want to program the iris scale.

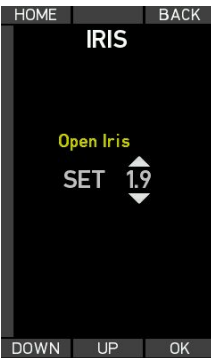

Use the iris slider to drive the lens iris scale to its open iris mark.  
 Use the **UP** and **DOWN** soft buttons or the zoom stick to set the open iris value on the display.  
 Press the **OK** soft button or the **USER** button to set the open iris point.



Use the iris slider to drive the lens iris scale to the next iris mark.  
 Press the **OK** soft button or the **USER** button to set the iris point.  
 Do the same for the following iris data points.



After entering all iris points, press the **OK** soft button to return to the *Select axis* screen.

If necessary, the programming can be finished before reaching the limit by pressing the **FINISH** soft button.

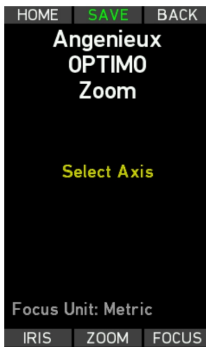

Select the lens axis to be programmed next.

Press the **ZOOM** soft button to program the zoom scale.

Skip this step if you do not want to program the zoom scale.



Use the slider to drive the lens zoom scale to its widest zoom mark.

Use the **UP** and **DOWN** soft buttons or the zoom stick to set the wide focal length value on the display.

Press the **OK** soft button or the **USER** button to set the focal length point.

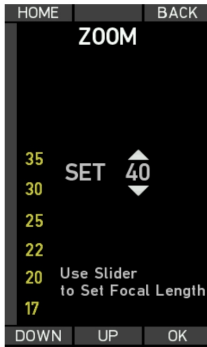

Use the iris slider to drive the lens zoom scale to the next focal length mark. Use the **UP** and **DOWN** soft buttons or the zoom stick to set the focal length value on the display. Press the **OK** soft button or the **USER** button to set focal length point. Do the same for the following focal length points.

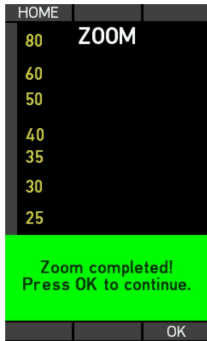

After entering all focal length points, press the **OK** soft button to return to the *Select axis* screen.

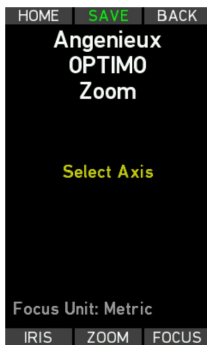

Press the **SAVE** soft button to save the lens file to the SD card (folder /ARRI/ALEXA/LDA). Make sure to have an SD card in the WCU-4!

Note: You can use the **FOCUS**, **IRIS** or **ZOOM** soft buttons to edit/check an existing scale or to reprogram an existing lens scale. See "Editing a lens file", page 59 to learn more about editing lens scales.

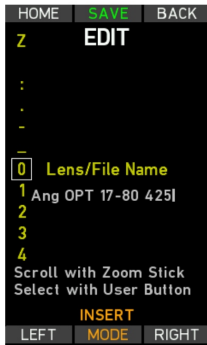

Before finally saving the lens file on SD card, you can edit the lens name that will be displayed on WCU-4, camera and motor controller. This name is also used as the name of the lens file.

Use the **MODE** soft button to select whether to insert, overwrite or delete a character.

Press the **SAVE** soft button to finally save the lens file to SD card folder /ARRI/ALEXA/LDA.

You can now upload the lens file from SD card to the camera or motor controller supporting LDA.

### ***Editing a lens file***

Existing lens files can be edited with the WCU-4 hand unit and then stored back on the SD card.

Load the lens file to edit onto an SD card in the folder (ARRI/ALEXA/LDA) and insert the SD card into the SD card slot of the WCU-4.

Go to *MENU > LENS DATA > LENS PROGRAMMING > EDIT LENS FILE.*

Use the **UP** and **DOWN** soft buttons or the zoom stick to scroll through the list of lens files on the SD card. Press the **SELECT** soft button or the **USER** button to select a lens file.

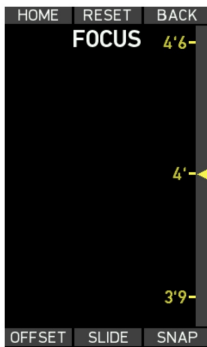

*Focus edit  
screen*

On the following screen, use the **FOCUS**, **IRIS** or **ZOOM** soft button to select the lens scale to edit. If metric and imperial scales exist, select the scale unit. The following screen (see image on the left) provides three different options (**OFFSET**, **SLIDE**, **SNAP**) for editing existing data points.

### Offset function

Use the **OFFSET** soft button to correct a fixed offset between the complete lens scale and the corresponding scale on the WCU-4 screen:

- 1 Select a reference witness mark on the WCU-4 display (e.g. infinity).
- 2 While keeping the **OFFSET** soft button pressed, drive the lens scale to the corresponding witness mark.
- 3 Release the **OFFSET** soft button when lens scale and display scale match.

### Slide function

Use the **SLIDE** soft button to correct an offset for a single data point:

- 1 Select the witness mark to edit on the WCU-4 display.
- 2 While keeping the **SLIDE** soft button pressed, drive the lens scale to the corresponding witness mark.
- 3 Release the **SLIDE** soft button when lens mark and display mark match.



### Snap function

Use the **SNAP** soft button to correct a slight offset for a single data point. The snap function will move the nearest available data point on the WCU-4 screen to the currently set lens position:

- 1 Drive the lens scale to a witness mark.
- 2 Press the **SNAP** soft button. The nearest available data point on the WCU-4 screen will jump to the currently set position.

Press the **RESET** soft button to reset all editing actions.

Press the **BACK** soft button to apply all editing actions and return to the Select Axis screen.

Press the **SAVE** soft button to save the lens file to SD card folder /ARRI/ALEXA/LDA. You can edit the lens name before saving.

### **Copy a lens file**

You can copy a lens file from one folder to another folder on the SD card. This can be particularly useful if you have your lens files organized in custom folders, but need to copy your favorites to ARRI/ALEXA/LDA for an ALEXA camera.

Remove the write-protection from the SD card and insert it into the SD card slot of the WCU-4. Go to *MENU > LENS DATA > LENS PROGRAMMING > COPY LENS FILE:*

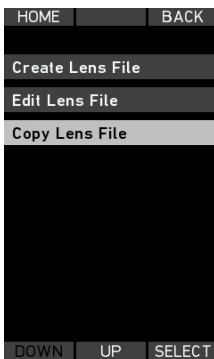

Select **COPY LENS FILE**.

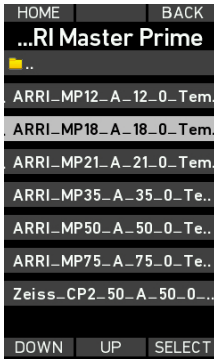

Use the **UP**, **DOWN** and **SELECT** soft buttons or zoom stick and User button to navigate through the folder structure on the SD card and select a lens file.

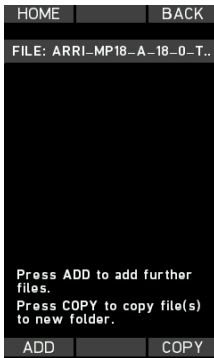

Press **ADD** to add further files or press **COPY** to navigate to the target folder.

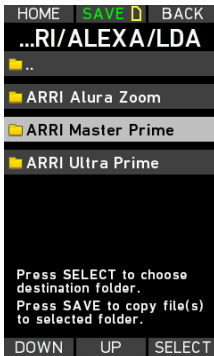

Press **SAVE** to save the selected files to the target folder.

## 10.5.2 Lens file transfer

Previously, lens files of lenses mapped for use with the ARRI Lens Data System had to be manually transferred to the ALEXA Mini via USB stick. Now, users can select a lens file stored on

the SD card in their WCU-4 and – using just the hand unit – wirelessly transmit the file to the ALEXA Mini, saving time and effort.

To transfer a lens file, insert the SD card with lens files on it into the SD card slot of the WCU-4. Go to *MENU > LENS DATA > LENS FILE TRANSFER*:



Select **LENS FILE TRANSFER**.

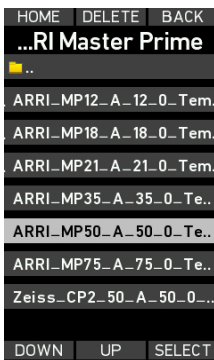

Use the **UP**, **DOWN** and **SELECT** soft buttons or zoom stick and User button to navigate through the folder structure on the SD card and select a lens file.



Press **SEND** to transmit the lens file wirelessly to the camera device. The transferred lens file is activated immediately.

### NOTICE

Lens file transfer is currently supported with ALEXA Mini, the Universal Motor Controller UMC-4 and the cforce mini RF lens motor!

### NOTICE

Lens file transfer is currently working with a limit of 99 lens files stored on SD card!

#### 10.5.3 Circle of confusion

Select the circle of confusion (COC) for correct depth of field calculation.

Use the **UP** and **DOWN** soft buttons or the zoom stick to scroll through the COC list. Press the **SET** soft button to select a circle of confusion.

#### 10.5.4 Global Unit

Go to MENU > LENS DATA > GLOBAL UNIT to reset the distance unit (metric or imperial) of the motor controller or cforce mini RF motor. Select *lens default* and press the **SELECT** soft button. After resetting the home screen shows no lens data.

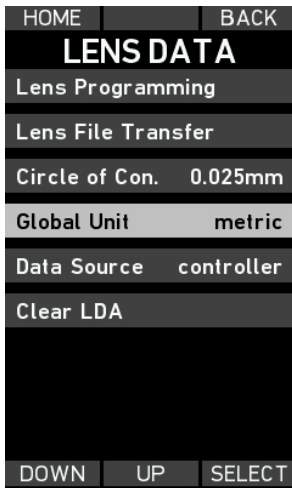

*Lens Data screen*

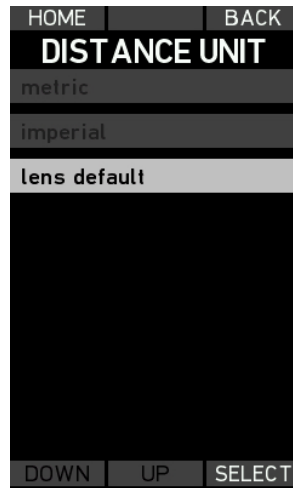

*Distance unit screen*

### 10.5.5 Data Source

In case a motor controller or cforce mini RF lens motor is connected to a camera select *Data Source* to set the lens data source:

- camera
- controller

Use the **UP** and **DOWN** soft buttons or the zoom stick to scroll through the Data Source list. Press the **SET** soft button to select a source.

If *camera* is selected, the WCU-4 uses an external (camera/LDS lens) lens data source.

If *controller* is selected, the WCU-4 uses the internal (LDA) lens data source. The lens file needs to be transferred from the WCU-4 to the motor controller or cforce mini RF.

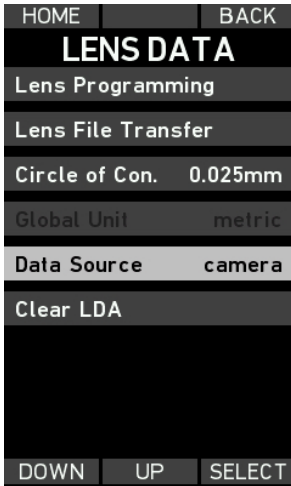

*Lens Data Menu  
screen*

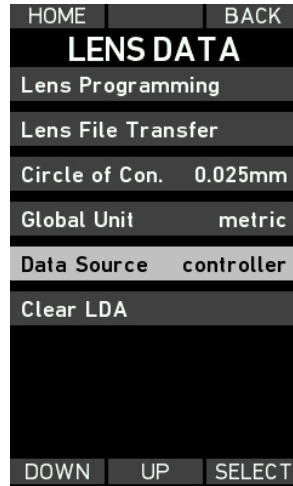

*Lens Data Menu  
screen*

### 10.5.6 Clear LDA

Select clear LDA to reset the LDA.

## 10.6 User buttons

The WCU-4's **USER** button (See "Layout", page 20) can be assigned to different functions.

Use the **UP** and **DOWN** soft buttons or the zoom stick to select the User button function. Press the **SET** soft button or the **USER** button to activate the setting.

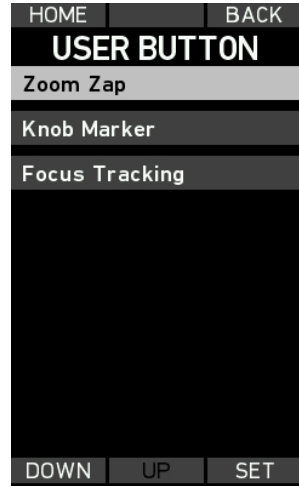

*User Button screen*

### Zoom Zap

Select *Zoom Zap* for fast zooming, e.g. to check focus. Having the **USER** button pressed will set the zoom speed to 100%.

### Knob marker

Select *Knob Marker* for setting digital focus marks on the WCU-4 lens data display. Pressing the **USER** button momentarily will add a new focus mark to the lens data display.

### Focus tracking

Select *Focus Tracking* to activate Focus Tracking mode. Having the **USER** button pressed will make the focus motor follow the measured value of the UDM-1 or other compatible distance measuring devices that are connected to the controller or camera (See "LDS - Lens Data System", page 17).

In case the WCU-4 is connected to the camera (See "Compatibility", page 84) the *User Button screen* shows *Camera User Buttons* which can be assigned to the WCU-4 USER button.

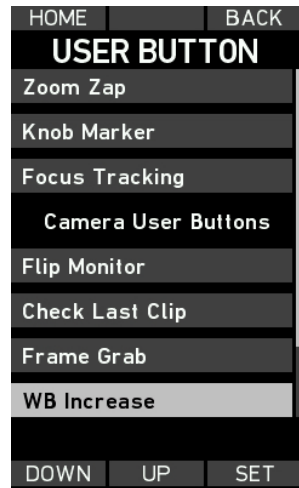

*User Button screen*



## 10.7 Backlight

The WCU-4 display, buttons and focus knob illumination can be dimmed according to operational needs. The Backlight menu lets you select a fixed or an automatic backlight mode. Press the **MODE** soft button to toggle between the two.

### Fixed mode

Select *Fixed Mode* to set a fixed value for the backlight intensity. Use the **UP** and **DOWN** soft buttons or the zoom stick to select the backlight level. Press the **SET** soft button or the User button to set the backlight level.

### Automatic mode

Select *Automatic Mode* to have an automatic backlight adjustment that depends on the ambient lighting conditions. Use the **UP** and **DOWN** soft buttons or the zoom stick to select the maximum possible backlight level. Press the **SET** soft button or the User button to set the backlight level.

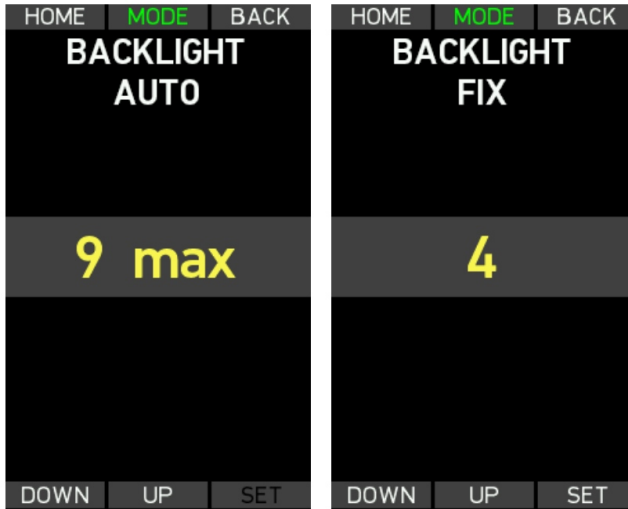

*Backlight screen*

## 10.8 User settings

### User settings

A user setting is a profile of WCU-4 settings. It can be saved to the SD card and be transferred to a different WCU-4. Up to six user settings can be stored on or recalled from an SD card.

#### Load setting

Select *Load Setting* and use the **UP** and **DOWN** soft buttons or the zoom stick to select a setting (Setting #1 to #6). Press the **LOAD** soft button or the User button to load the setting.

#### Save setting

Select *Save Setting* and use the **UP** and **DOWN** soft buttons or the zoom stick to select the location you want to save a new setting to (Setting #1 to #6). Press the **SAVE** soft button or the User button to save the setting to the currently selected location. This will overwrite the previous setting.



*User settings menu screen*

#### Factory reset

Select *Factory Reset* to reset the WCU-4 to its factory default settings.

## 10.9 Firmware

Always update the WCU-4 with the latest firmware. In addition, licensed features are available. WCU-4 software licenses are bound to the WCU-4's serial number.

Enter the *Update* screen to install a new Software Update Package or a new license key.

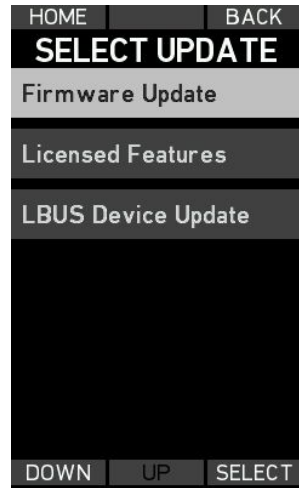

### Firmware update

Update the WCU-4 firmware as follows:

- 1 Download the Software Update Package from the ARRI website at [www.arri.com](http://www.arri.com)
- 2 Copy the Software Update Package in the root directory of an SD card (FAT16 or FAT32 formatted).
- 3 Insert the SD card into the SD card slot of the WCU-4.
- 4 Turn on the WCU-4.
- 5 Go to *MENU > UPDATE > FIRMWARE UPDATE*
- 6 Use the **UP** and **DOWN** soft buttons or the zoom stick to scroll through the list of update files on the SD card. Press the **SELECT** soft button or the User button to select an update file.
- 7 Press the two **UPDATE** soft buttons simultaneously to start the update.
- 8 The update process takes about 5 seconds. The WCU-4 will restart, and the update process is completed.

## ATTENTION!

Note: Be sure that the battery is completely charged before starting any update!

**Caution:** Do not remove the SD card while the update file is being copied to the WCU-4!

Do not remove the battery until the WCU-4 has re-started automatically after update.

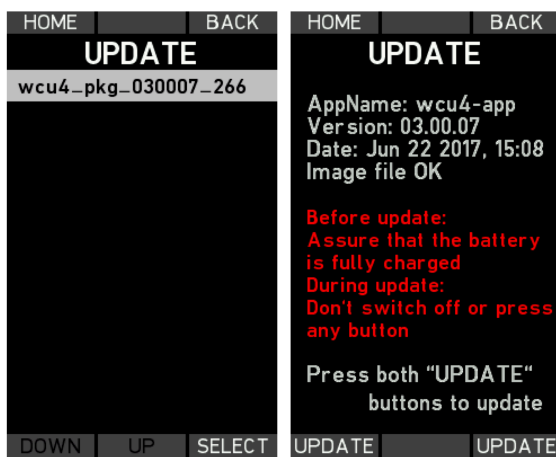

*Firmware Update screens*

### Installing a License

Before purchasing a license key, please save the WCU-4's hardware info file for upload during the purchasing process:

- 1 Switch the WCU-4 on.
- 2 Insert the SD card into the SD card slot of the WCU-4.
- 3 Go to *MENU > UPDATE > LICENSED FEATURES*.
- 4 Press the **HWINFO** soft button. A file named "K2.72103.0-####- wcu4.ipkg" (with #### being the WCU-4 serial number) will be stored on the SD card in the folder /ARRI/ WCU4/Licenses.

- 5 Visit the ARRI license shop at <http://alshop.arri.de> and follow the instructions for purchasing and downloading license keys. This includes uploading the hardware info file.
- 6 Download the license key file and copy it to the SD card, to the folder /ARRI/WCU4/Licenses.
- 7 Insert the SD card into the SD card slot of the WCU-4.
- 8 Go to *MENU > UPDATE > LICENSED FEATURES*.
- 9 Press the **INSTALL** soft button and select a license file from the *INSTALL LICENSE* screen using the **UP/DOWN** soft buttons or the zoom stick.
- 10 Press the **INSTALL** soft button again, and then confirm your selection by pressing both **INSTALL** soft buttons.
- 11 The installed license will be indicated on the Licenses screen.

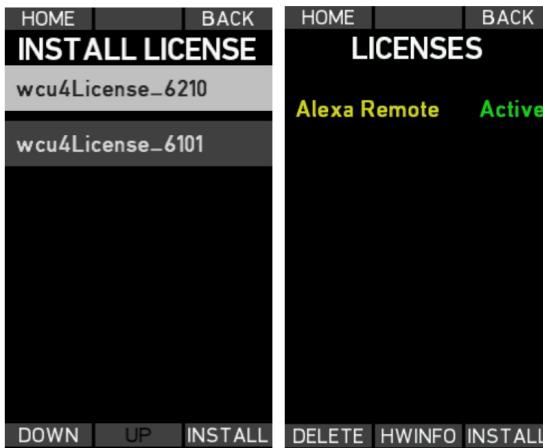

*License screens*

### Deleting a license

- 1 Press the **DELETE** soft button and select a license file using the **UP/DOWN** soft buttons or zoom stick.
- 2 Press the **DELETE** soft button again, then confirm your selection by pressing both **DELETE** soft buttons simultaneously.
- 3 Once purchased, a license key can be re-installed again to the corresponding WCU-4 at any time.

#### 10.9.1 LBUS update

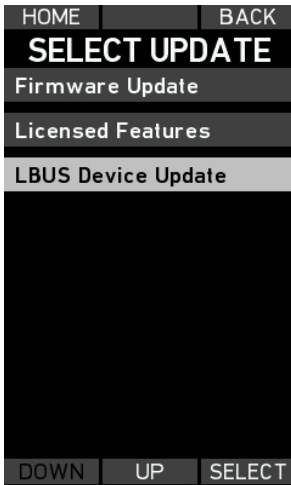

The WCU-4 offers the possibility to update LBUS devices. Therefore connect the device with a LCS to LBUS cable. To power the LBUS, it's recommended to use an additional power supply cable. (See "Part numbers", page 82)



Select the device which should be updated.

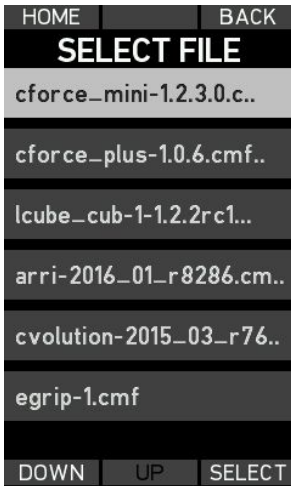

Select the update file. It should be located in the root directory on the FAT16/32 formatted SD card.



Start the update by pressing both **UPDATE** soft buttons simultaneously.

Do not switch off the WCU-4 or the LBUS devices. Do not unplug the LBUS cable, or remove the SD card.

## 10.10 System info

The *System Info* screen shows the firmware version and WCU-4 serial number, the network (MAC) address and firmware version of the installed radio module, and the network address of the connected motor controller.

Enter the *RADIO SETTINGS* via the **REGION** soft button.





### 10.10.1 Region settings

The WCU-4 offers radio settings for different areas (from SUP 02.02.10 and with white-radio module EMIP300). Make sure that you select the proper area you are operating the device in. All available region settings comply with Part 15 of the FCC rules.

- 1 Go to *MENU > SYSTEM INFO > RADIO > REGION*.
- 2 Use the **UP** and **DOWN** buttons to select the region you are in.
- 3 Select *WORLD* if your specific region is not listed. (The *WORLD* setting provides a radio output power of 10 dBm and complies with Part 15 of the FCC rules. Please make sure that this complies with the local radio laws.) For the region India it is recommended to select the region USA.
- 4 Press the **SELECT** soft button to activate the new region setting.





#### NOTICE



If the master device (camera or motor controller) is also equipped with a radio module which is able to set regions, the master will override the region settings of the WCU-4 with its settings.



# 11 Appendix



## 11.1 Screen icons



- 

IRIS  Iris motor connected, but not available for the WCU-4, e.g. control through another remote unit. Equivalent for zoom motor and focus motor.
- 



IRIS  No iris motor connected. Equivalent for zoom motor and focus motor.
- 



IRIS  Iris motor status unknown, e.g. during system startup. Equivalent for zoom motor and focus motor.
- 

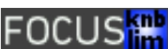

ZOOM  Zoom motor locked. Equivalent for iris motor and focus motor.
- 



FOCUS  Focus motor limits set. Equivalent for zoom motor and iris motor.
- 



FOCUS  Focus knob limits set.
- 



FOCUS  Focus motor limits combined with knob limit.
- 

OFFS.  Focus offset is set.
- 

 30 Zoom motor speed value set to 30%.
- 

CAM  Camera information, check camera info screen.
- 

CAM  Critical CAM information, check camera info screen.
- 

 2  Radio connection active.



Radio connection disabled.



WCU-4 is hardwired with motor controller or camera.



Low battery.

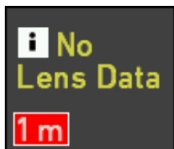

Premarked focus ring active, but no lens data available from motor controller.

## 11.2 SD card

This device only works with FAT16 or FAT32 formatted SD cards up to 32GB (limiting the number/size of files).

## 11.3 Screen messages

Interface	Description
HW Info file could not be stored. Please insert SD card.	Insert an SD-card.
License file not valid!	The license file on the SD card does not correspond to the WCU-4 serial number.
Used path not found!	Create a valid folder structure on the SD card.
Disabled during record	Function not available during camera record.
Calibrate lens motors now?	Calibrate lens motors (recommended). If you are sure that nothing has been changed since the last calibration, press <b>CANCEL</b> .
Motors calibrating ...	Wait until calibration is finished.
New IRIS Motor! Connect?	Indicates that an iris motor has been connected to the running system. Press the <b>YES</b> soft button to assign the motor to the iris slider. Equivalent for zoom and focus motor.

<b>Interface</b>	<b>Description</b>
Warning! Second motor controller detected! Select another channel!	The WCU-4 is connected to one motor controller and has detected a second motor controller on the same radio channel. Select another radio channel to resolve this situation.
No connection to host no transfer possible	The WCU-4 handset is not connected to any camera device.
Transfer not Ok. Error.	The lens file transfer was unsuccessful. This is the case with cameras/motor controllers that don't support wireless lens file transfer.

## 11.4 Part numbers

### Wireless Compact Unit WCU-4

K2.72103.0	Wireless Compact Unit WCU-4
K2.72117.0	White Focus Ring for WCU-4 or SXU-1 (included in K2.72103.0)
K2.0002067	Hand Strap for WCU-4 (included in K2.72103.0)
K2.0002069	Lanyard for WCU-4 (included in K2.72103.0)

### Pre-marked focus rings

K2.0001651	Pre-Marked Focus Ring 0.20m for WCU-4
K2.72129.0	Pre-Marked Focus Ring 0.25m for WCU-4
K2.72130.0	Pre-Marked Focus Ring 0.35m for WCU-4
K2.72131.0	Pre-Marked Focus Ring 0.50m for WCU-4
K2.72132.0	Pre-Marked Focus Ring 1.00m for WCU-4
K2.0001652	Pre-Marked Focus Ring 8" for WCU-4
K2.72133.0	Pre-Marked Focus Ring 12" for WCU-4
K2.72134.0	Pre-Marked Focus Ring 14" for WCU-4
K2.72135.0	Pre-Marked Focus Ring 20" for WCU-4
K2.72136.0	Pre-Marked Focus Ring 3'6 for WCU-4

### Power supplies

K2.47851.0	NP-FM500H Battery (Sony)
K2.0002065	BC-QM1 Battery Charger (Sony)
K2.0000425	Hand Unit AC Power Supply HPS-1

## Cables

K2.0002136	Cable LCS to LCS 3.5m/11ft
K2.0002141	Cable LCS to LCS coiled
K2.41389.0	LCS Cable Drum Extension 75m/250ft
K2.0007624	Cable ALEXA mini to LCS
K2.0007318	Cable LBUS to LCS 0,8m/2.5ft

## Miscellaneous



K2.0006501 WCU-4 Plate



K2.0008271 WCU-4 Monitor Mount



K2.72146.0 Carrying case for WCU-4 and accessories



10.0000268 ALEXA Remote License for WCU-4 (available from ARRI license shop: <http://alshop.arri.de>)

## 11.5 Compatibility

To use the WCU-4 wireless, the corresponding device needs a white-coded radio modem.

The Wireless Compact Unit WCU-4 is compatible with the following ARRI products:

### Cameras

- ALEXA Mini

- Direct compatible with WCU-4 wireless and wired (Cable ALEXA mini to LCS needed - K2.0007624).
- Camera control - ALEXA Remote license needed (See "Miscellaneous", page 83). Following control functions are provided: Frame Rate, Shutter Angle, Exposure Index, White Balance, ND Filter, Monitor Output (SDI) Configuration, User Button Access, Playback control, Wireless lens file transfer, Remote camera user setup, Motor gear teeth detection.
- Lens data transmission and distance readings from UDM-1 via LBUS (LCUBE CUB-1 required - K0.0010104).
- Control of cforce mini/Plus motors via LBUS.

- ALEXA SXT Plus
- ALEXA SXT W
- ALEXA 65

- Direct compatible with WCU-4 wireless and wired.
- Lens data transmission and distance readings from UDM-1.
- Control of up to three passive motors.



- Camera control - ALEXA Remote license needed (See "Miscellaneous", page 83). Following control functions are provided: Frame Rate, Shutter Angle, Exposure Index, White Balance, ND Filter (ALEXA Studio only), Monitor Output (SDI) Configuration, User Button Access, Live camera information.

### **NOTICE**

No Lens File Transfer and Playback possible!

- ALEXA LF

- Direct compatible with WCU-4 wireless and wired.
- Lens data transmission and distance readings from UDM-1.
- Control of up to three passive motors.
- Control of up to three active motors via LBUS (cforce mini/plus/mini RF).
- Camera control - ALEXA Remote license needed (See "Miscellaneous", page 83). Following control functions are provided: Frame Rate, Shutter Angle, Exposure Index, White Balance, ND Filter, Monitor Output (SDI) Configuration, User Button Access, Live camera information.
- Supports override function of WCU-4 triggered by the Operator Control Unit OCU-1 or the Master Grips (2.0).

### **NOTICE**

No Lens File Transfer and Playback possible!

- ALEXA XT Plus
- ALEXA XT M
- ALEXA Studio

- Direct compatible with WCU-4 wireless and wired.
- Camera control - ALEXA Remote license needed (See "Miscellaneous", page 83). Following control functions are provided: Frame Rate, Shutter Angle, Exposure Index, White Balance, ND Filter (ALEXA Studio only), Monitor Output Configuration, User Button Access.
- Lens data transmission and distance readings from UDM-1.
- Control of up to three passive motors.

### **NOTICE**

No Lens File Transfer and Playback possible!

- AMIRA
- ALEXA Classic
- ALEXA XT

- Camera control with the UMC-4 and cforce mini RF. ALEXA Remote license needed (See "Miscellaneous", page 83). Following control functions are provided: Frame Rate, Shutter Angle, Exposure Index, White Balance, ND Filter (Amira only), Monitor Output Configuration, User Button Access.

### **NOTICE**

No Lens File Transfer and Playback possible!

## Motor controllers

### UMC-4

#### Universal Motor Controller

- Wireless and wired control.
- Camera control of connected camera - ALEXA Remote license is required.
- Control up to 3 motors (active/passive mixed). For active motors the cable K2.0007318 is needed, also an additional power supply cable for LBUS is recommended.
- UDM-1 distance data
- LDA (Lens data archive) and lens programming.
- Fujinon and Canon demands - see UMC-4 manual for further details.

### SMC-1

#### Single Motor Controller

- Wireless and wired control.
- Control one passive motor.

### AMC-1

#### Active Motor Controller

- Wireless and wired control.
- Control up to 3 active motors.

### EMC-1

#### ENG Motor Controller

- Wireless and wired control.
- Control ENG-Type lenses
- Lens data is transmitted to the WCU-4

**cforce mini RF**  
aktive lens motor

- Wireless and wired control
- Camera control of connected camera
- ALEXA Remote license is required
- Control up to 3 cforce motors
- UDM-1 distance data via CUB-1
- LDA (Lens data archive) and lens programming

**External zoom controllers**

- Master Grip
- Operator Control Unit OCU-1
- Zoom Main Unit ZMU-3A
- cmotion pan-bar zoom

**NOTICE**

For questions about hardware not listed above please contact [service@arri.com](mailto:service@arri.com).

## 11.6 Pinouts

### LCS connector

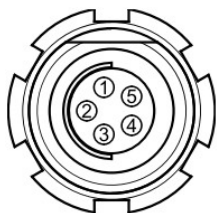

1	GND	Ground
2	n.c.	
3	CAN-L	CAN bus
4	CAN-H	CAN bus
5	+V-BAT	Battery supply output

## 11.7 Dimensions and weight

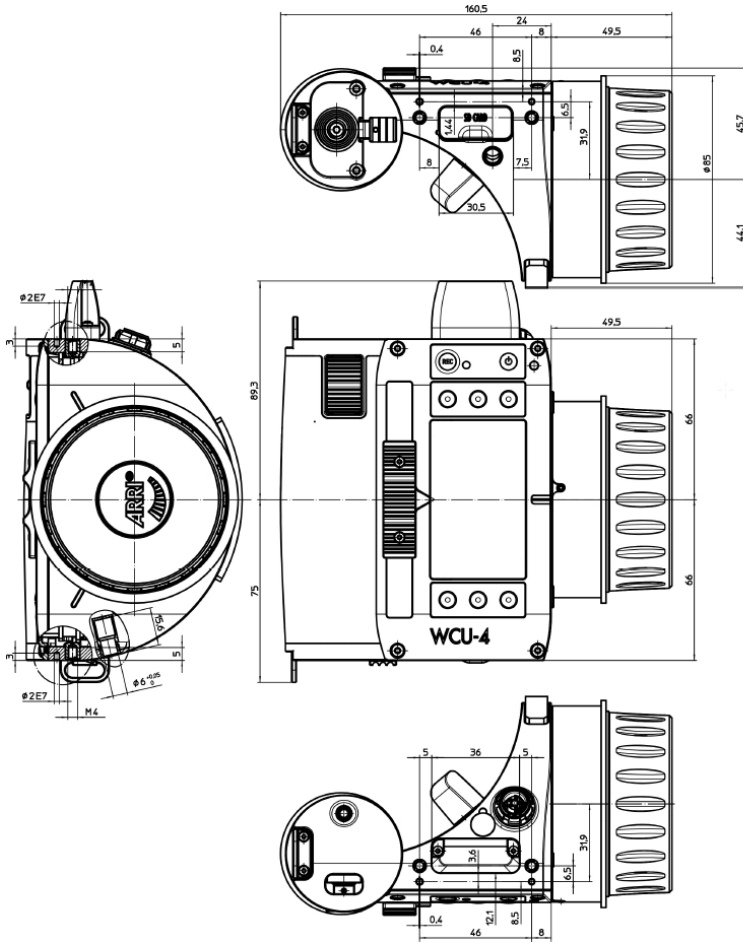

Weight (without straps and battery): 730g / 25.8oz.

## Electrical data

Battery:	7.2 V Li.Ion, 11.8 Wh
LCS:	10.4 V to 34 V DC
Power consumption:	220 mA@7.2 V 70 mA@24 V
Operating temperature:	-20 to +50 °C -4 to +122 °F

## 11.8 Radio system

The WCU-4 contains a radio unit that enables wireless lens control with a white coded radio module. A white ring at the base of the antenna socket identifies it. There are 14 channels to choose from:

Channel	Frequency
0	2.410 GHz
1	2.415 GHz
2	2.430 GHz
3	2.435 GHz
4	2.450 GHz
5	2.455 GHz
6	2.470 GHz
7	2.475 GHz
8	2.420 GHz
9	2.425 GHz
10	2.440 GHz
11	2.445 GHz

12	2.460 GHz
13	2.465 GHz

White radio and legacy yellow radio cannot be mixed in the same radio network of the camera and its hand units. However, both systems can be used parallel in different radio networks.

## 11.9 Service mode

The service mode offers recalibration of focus knob, iris slider and zoom stick. This particularly fixes a potential non-linearity of the focus knob that can cause a misalignment with pre-marked focus rings and hand-marked rings that are exchanged between various WCU-4 units.

All WCU-4 units above serial number 6262 are delivered with the extended knob calibration from the factory and usually do not need a re-calibration.

### **ATTENTION!**

Note: Do **ONLY** use the service mode if you experience issues and need to re-calibrate the WCU-4 control devices! Make sure that you understand the calibration procedure before using it.

To avoid unexpected interaction with an occasionally connected motor controller, be sure the radio is disabled and no cable is connected to the LCS socket.



To enter service mode, power up the unit by simultaneously pressing and holding both upper and lower center soft buttons and the **POWER** button until the *SERVICE MODE* main screen appears.

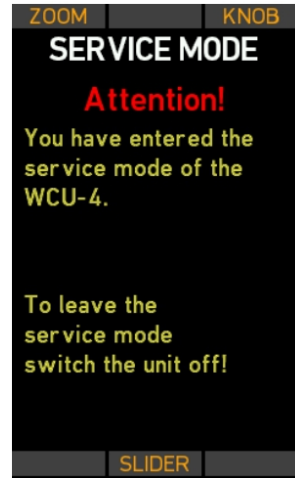

## Zoom calibration mode

Press the **ZOOM** soft button to enter the *Stick Setup* screen.

If the zoom control acts in the wrong direction, move the zoom stick upwards and press ADJ-DIR.

If the zoom zero position is not correct (issue: the zoom motor moves without pressing the stick), leave the zoom stick in its center position (do not touch it) and press ADJ-0.

Press **BACK** to return to the *SERVICE MODE* main screen. The new calibration becomes effective after rebooting the WCU-4.

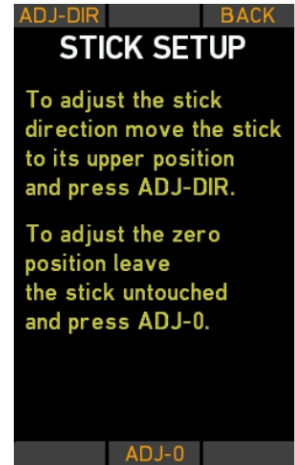

## Knob calibration mode

Press the **KNOB** soft button to enter the *Knob Setup* screen.

Turn the knob clockwise to its end position and press **K-CW**. Then turn the knob counter-clockwise to its end position and press **K-CCW**.

Attach the WCU-4 Knob Calibration Ring K2.0000848.

Press **TEST** to check if the engravings on the Knob Calibration Ring align with the corresponding values on the WCU-4 screen. If they do not align, press the **K-LIN** soft button to start the knob linearizing procedure.

### **NOTICE**

Do not start the linearizing procedure without the ARRI calibration ring applied. Once started, you must go through the whole alignment procedure.

By pressing **K-LIN** all previously stored alignment points will be cleared and cannot be restored!

Please note that previously hand-marked focus rings might have an offset after re-calibrating the focus knob!

Turn the knob exactly to ring position number 1 and press the **SET1** soft button to confirm and store the alignment position. Repeat the procedure until you finish with position 16.

Press the **UNDO** soft button if you missed the correct alignment position and repeat the last step.

Press the **READY** soft button at the end of the procedure to return to the *SERVICE MODE* screen.

The new calibration becomes effective after rebooting the WCU-4.

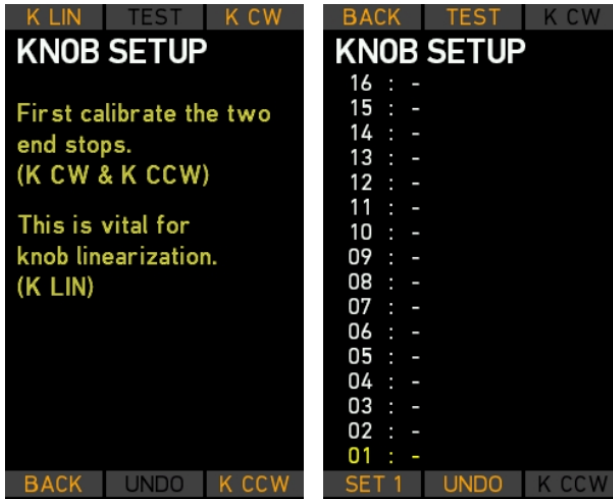

*Knob Setup screens*

## Slider Calibration Mode

Press the **SLIDER** soft button to enter the *Slider Setup* screen.

Move the slider to its top-end position, then press **S-UP**.

Move the slider to its bottom-end position, then press **S-DOWN**.

Move the slider exactly to the "0" position on the display and press **SET 0** to confirm and store the alignment position. Repeat the procedure until you finish with position 12.

Press the **READY** soft button at the end of the procedure to return to the *SERVICE MODE* screen.

The new calibration becomes effective after rebooting the WCU-4.



Note: Be aware of a possible parallax error between the slider pointer and the displayed alignment bar.

## 11.10 Service Contacts

### **Munich, Germany**

ARRI Cine + Video Technik

+49 89 3809 2121

service@arri.de

Business hours:

Mo. - Fr. 9:00 - 17:00 (CET)

### **London, Great Britain**

ARRI CT Limited

+44 1895 457 051

service@arri-ct.com

Business hours:

Mo. - Thu. 9:00 - 17:30

Fr. 9:00 - 17:00 (GMT)

### **Burbank, USA**

ARRI Inc. West Coast

+1 877 565 2774

service@arri.com

Business hours:

Mo. - Fr. 8:15 - 17:00 (PST)

### **Mississauga, Canada**

ARRI Canada Limited

+1 416 255 3335

service@arri.com

Business hours:

Mo. - Fr. 8:30 - 17:00 (EDT)

### **Beijing, China**

ARRI China Co. Limited

+86 10 5900 9680

service@arrichina.com

Business hours:

Mo. - Fr. 9:00 - 18:00 (CST)

### **Vienna, Austria**

ARRI Cine + Video Geräte  
Ges.m.b.H.

+43 1 8920107 30

service@arri.at

Business hours:

Mo. - Fr. 9:00 - 17:00 (CET)

### **Milan, Italy**

ARRI Italia S.r.l.

+39 (02) 262 271 75

info@arri.it

Business hours:

Mo. - Fr. 9:00 - 18:00 (CET)

### **New York, USA**

ARRI Inc. East Coast

+1 877 565 2774

service@arri.com

Business hours:

Mo. - Fr. 8:00 - 17:30 (EST)

### **Hong Kong, China**

ARRI Asia Limited

+852 2537 4266

service@arriasia.hk

Business hours:

Mo. - Fr. 10:00 - 18:30 (HKT)

### **Sydney, Australia**

ARRI Australia Pty Ltd

+61 2 9855 4305

service@arri.com.au

Business hours:

Mo. - Fr. 8:00 - 18:00 (AEST)

## 11.11 International declarations

### EC Declaration of Conformity

The designated product WCU-4 conforms to the specifications of the following European directives:

- Directive 2014/53/EU of the European Parliament and the Council of 16 April 2014 on the harmonisation of the laws of the Member States relating to the making available on the market of radio equipment - OJ L 153, 22 May 2014, p. 62–106
- Directive 2011/65/EU of the European Parliament and the Council of 8 June 2011 on the restriction of the use of certain hazardous substances in electrical and electronic equipment - OJ L 174, 1 July 2011, p. 88–110

The compliance with the requirements of the European Directives was proved by the application of the following standards:

Essential Requirements regarding No 1

Art. 3.1 a following 2014/35/EU

- EN 62368-1:2014 + AC:2015-05 + AC:2015-11;

Art. 3.1 b following 2014/30/EU

- EN 301 489-1 V1.9.2; EN 301 489-17 V2.2.1

Art. 3.2

- EN 300 328 V2.1.1; EN 301 893 V1.8.1

Essential Requirements regarding No 2

- EN 50581:2012;

To evaluate the respective information, we used:

[http://ec.europa.eu/growth/single-market/european-standards/harmonised-standards/index\\_en.htm](http://ec.europa.eu/growth/single-market/european-standards/harmonised-standards/index_en.htm)

Year of affixed CE-marking: 2013

München, den 04.05.2018

sign. Walter Trauninger

*Managing Director*

sign. Dr. Sebastian Lange

*Head of Quality Management*

## **FCC Class A Statement**

Note: This equipment has been tested and found to comply with the limits for a Class A digital device, pursuant to Part 15 of the FCC Rules. These limits are designed to provide reasonable protection against harmful interference when the equipment is operated in a commercial environment. This equipment generates, uses, and can radiate radio frequency energy and, if not installed and used in accordance with the instruction manual, may cause harmful interference to radio communications. Operation of this equipment in a residential area is likely to cause harmful interference in which case the user will be required to correct the interference at their own expense.

## **Industry Canada Compliance Statement**

Complies with the Canadian ICES-003 Class A specifications. Cet appareil numérique de la Classe A est conforme à la norme NMB-003 du Canada. This device complies with RSS 210 of Industry Canada. Cet appareil est conforme à CNR-210 d'Industrie Canada. This Class A device meets all the requirements of the Canadian interference-causing equipment regulations. Cet appareil numérique de la Classe A respecte toutes les exigences du Règlement sur le matériel brouilleur du Canada.

## **Japan MIC Statement**

Complies with Ministry of Internal Affairs and Communications notification Article 88, Annex 43.

## **India WPC Compliance Statement**

The WCU-4 contains the following radio module: ECS transceiver module: ETA-1180/2017/ERLO

## Radio Module

The WCU-4 contains the following radio module:

FCC ID: Y7N-EMIP300

IC ID: 9482A-EMIP300

MIC ID: 011-150023

ETA-1180/2017/ERLO

### ***NOTICE***

It may not be legal to operate Wireless Compact Unit WCU-4 in a country/region other than the country/region selected in the WCU-4 region menu. Switch radio off and use the device in hardwired mode if you are not sure of the correct region setting.